

650V, 80mΩ, 40.8 Amp Super Junction Power

Ordering Information

Part Number	Package Option
D3S080N65B-U	TO-220
D3S080N65D-U	TO-247
D3S080N65E-U	TO-263
D3S080N65F-U	TO-220 Fullpak

Description

+FET™ is an advanced Super Junction Power MOSFET offering excellent efficiency through low $R_{DS(ON)}$ and low gate charge. +FET™ is a rugged device with precision charge balance implementation designed for demanding uses such as enterprise power computing power supplies, motor control, lighting and other challenging power conversion applications.

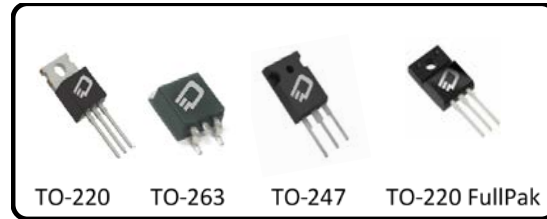
Features

- LOW $R_{DS(ON)}$
- FAST SWITCHING
- HIGH E_{AS}
- REL TEST SPEC: JESD-22
- HTRB >3000 HRS

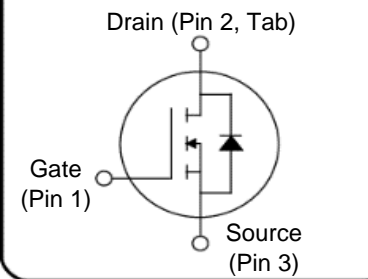
Table 1 Key Parameters

Parameter	Value	Unit
V_{DSS} @ T_{jmax}	710	V
$R_{DS(on)}$ max	< 80	mΩ
Q_g typ	77	nC
I_D @ 25 °C	40.8	A

Package Options



Device Schematic



Benefits

- LOW CONDUCTION LOSSES
- HIGH EFFICIENCY
- EXCELLENT AVALANCHE PERFORMANCE

Applications

- POWER FACTOR CORRECTION
- SERVER POWER SUPPLIES
- TELECOM POWER SUPPLIES
- INVERTERS
- MOTOR CONTROL

Contents

Contents.....	2
Maximum Ratings	3
Thermal Characteristics	4
Electrical Characteristics	5
Electrical Characteristics Graphs.....	7
Revision History.....	16
Resources	16
Patents, Copyrights and Trademarks	16

Maximum Ratings

Parameter	Symbol	Values				Unit	Condition
		Min	Typ	Max			
Continuous drain current	I _D			40.8	20.3	A	T _c = 25°C
				25.8	12.8	A	T _c = 100°C
Pulsed drain current	I _{D, pulse}			175	81	A	T _c = 25°C
Avalanche energy, single pulse	E _{AS}			650	650	mJ	I _D = 7.2A; V _{DD} = 50V, V _{GS} = 10V, L=10mH, RG=25 Ohms
Avalanche energy, repetitive	E _{AR}			1	1	mJ	I _D = 7.2; V _{DD} = 50V
Avalanche current, repetitive	I _{AS}			8.7	8.7	A	
MOSFET dv/dt ruggedness	dv/dt			50	50	V/ns	V _{DS} = 0...480V
Gate source voltage (static)	V _{GS}	-30		30	30	V	Static
Gate source voltage (dynamic)	V _{GS}	-30		30	30	V	AC (F>1Hz)
Power dissipation	P _{tot}			305	60	W	T _c = 25°C
Storage temperature	T _{stg}	-55		150	150	°C	
Operating junction temperature	T _j	-55		150	150	°C	
Mounting torque				60		N-cm	M3 and M3.5 screws
					50	N-cm	M3 screw
Isolation Voltage*	V _{ISO}	3.5				kV	TO-220 FullPak Only
Continuous diode forward current	I _{SD}			43.6	20.3	A	T _c = 25°C
Diode pulse current	I _{S, pulse}			175	81	A	T _c = 25°C
Reverse diode dv/dt	dv/dt			15	15	V/ns	V _{DS} =0...480V, I _{SD} <=I _S , T _j = 25°C
Maximum diode commutation speed	di _i /dt			500	500	A/μs	V _{DS} =0...480V, I _{SD} <=I _S , T _j = 25°C

Thermal Characteristics

Table 3 Thermal Characteristics

Symbol	Parameter	Packages				Unit
		TO-220	TO-263	TO-247	TO-220FP	
R_{thC}	Thermal resistance, junction-case	0.41	0.41	0.41	1.89	°C/W
R_{thA}	Thermal resistance, junction-ambient	42	42	42	44	°C/W
R_{thT}	Thermal resistance, junction-ambient for SMD version		30			°C/W
T_s	Soldering temperature, wavesoldering only allowed at leads	260	260	260	260	°C

Electrical Characteristics

@ T_j = 25°C, unless otherwise specified

Table 4

Parameter	Symbol	Values			Unit	Condition
		Min	Typ	Max		
Drain-source breakdown voltage	V _{DSS}	650			V	I _D = 1mA, V _{GS} = 0V
Gate threshold voltage	V _{(GS)th}	2.3	3	3.7	V	
Zero gate voltage drain current	I _{DSS}			1	μA	V _{DS} = 650V, T _C = 25°C
				50		V _{DS} = 650V, T _C = 125°C
Gate-source leakage current	I _{GSS}			100	nA	
Drain-source on-state resistance	R _{DS(on)}		0.062	0.080	Ω	V _{GS} = 10V, I _D = 15.9A, T _C = 25°C
	R _{DS(on)}		0.183			V _{GS} = 10V, I _D = 10 A, T _C = 150°C
Gate resistance	R _G		1		Ω	

Table 5

Parameter	Symbol	Values			Unit	Condition
		Min	Typ	Max		
Input capacitance	C _{iss}		4240		pF	V _{DS} = 100V, f = 1MHz, V _{GS} = 0V
Output capacitance	C _{oss}		97.5		pF	
Reverse transfer capacitance	C _{rss}		16.5		pF	
Turn-on delay time	t _{d(on)}		17		ns	V _{DD} = 400V, I _D = 15.9A R _G = 1Ω, V _{GS} = 10V
Rise time	t _r		24		ns	
Turn-off delay time	t _{d(off)}		90		ns	
Fall time	t _f		23		ns	

Table 6 Gate Charge Characteristics

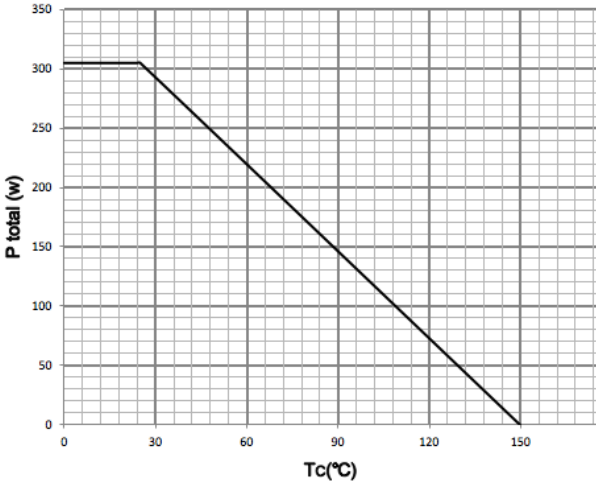
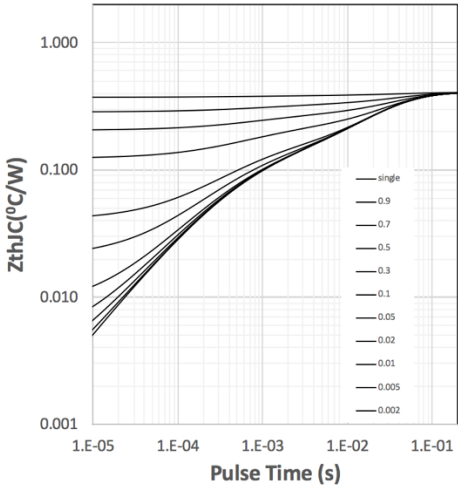
Parameter	Symbol	Values			Unit	Condition
		Min	Typ	Max		
Gate to source charge	Q_{gs}		16		nC	$V_{DD} = 480V, I_D = 15.9A,$ $V_{GS} = 10V$
Gate to drain charge	Q_{gd}		27		nC	
Gate charge total	Q_g		77		nC	
Gate plateau voltage	$V_{plateau}$		5		V	

Table 7 Body Diode

Parameter	Symbol	Values			Unit	Condition
		Min	Typ	Max		
Diode source-drain current	I_{SD}			43.6	A	
Diode forward voltage	V_{fd}		0.95	1.5	V	$I_{SD} = 31.8A, V_{GS} = 0V$
Reverse recovery time	t_{rr}		468		ns	$I_{SD} = 31.8A, di/dt = 100A/\mu S$ $V_{DD} = 60V, T_C = 25^\circ C$
Reverse recovery charge	Q_{rr}		9.5		μC	
Peak reverse recovery current	I_{rrm}		50.0		A	

Electrical Characteristics Graphs

Table 8 Thermal Performance

Power Dissipation TO220, TO247, TO263	Maximum Transient Thermal Impedance
	
Max power limited by case temperature	Variable is pulse time (t_p) TO220, TO247, TO263

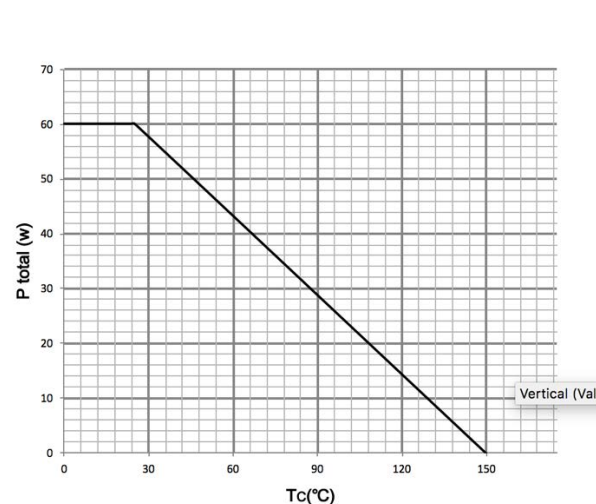
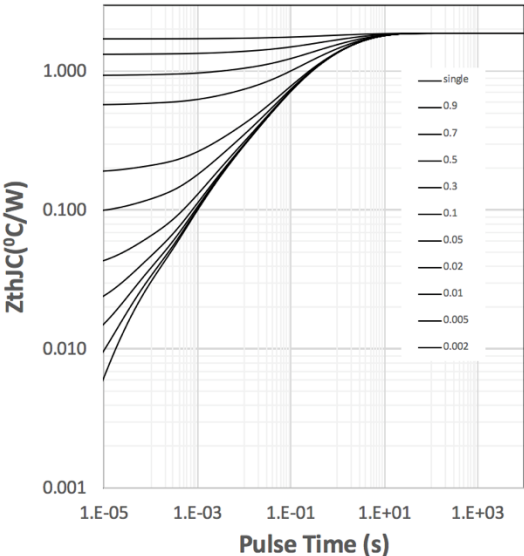
Power Dissipation TO220FP	Maximum Transient Thermal Impedance (TO220FP)
	
Max power limited by case temperature	Variable is pulse time (t_p) TO220FP

Table 9 Output Characteristics

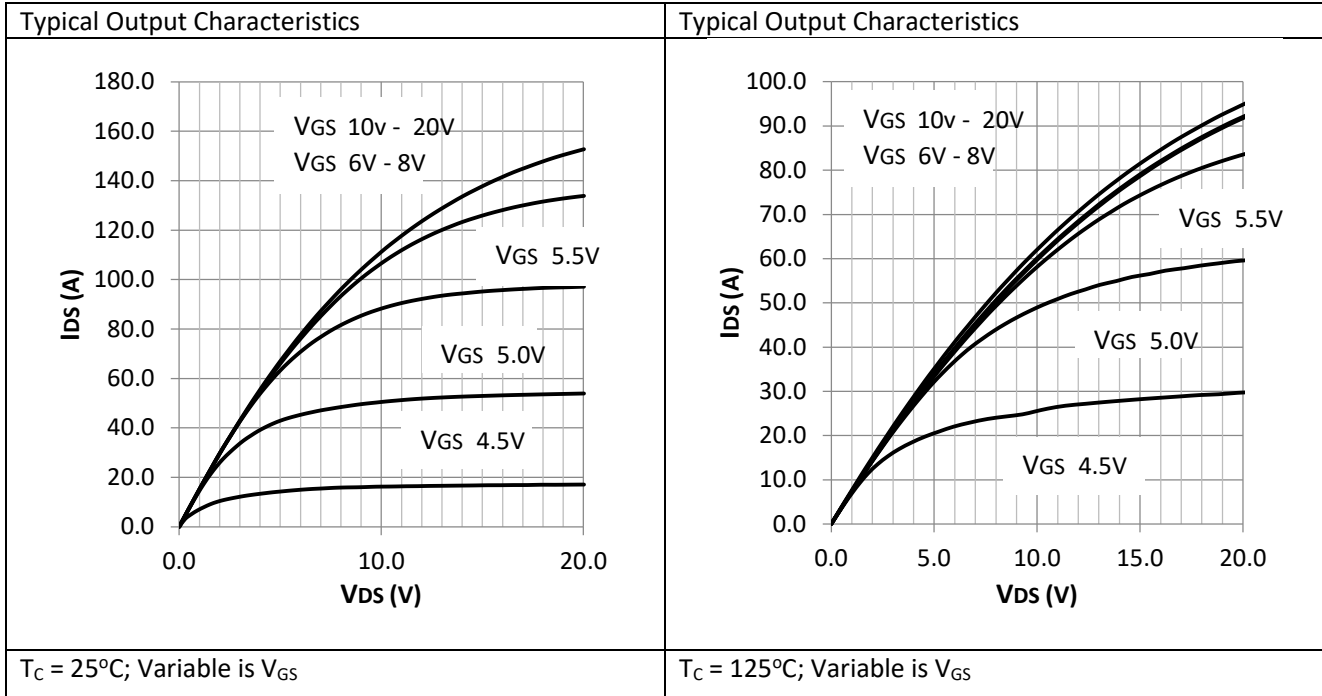


Table 10 Drain-Source Resistance

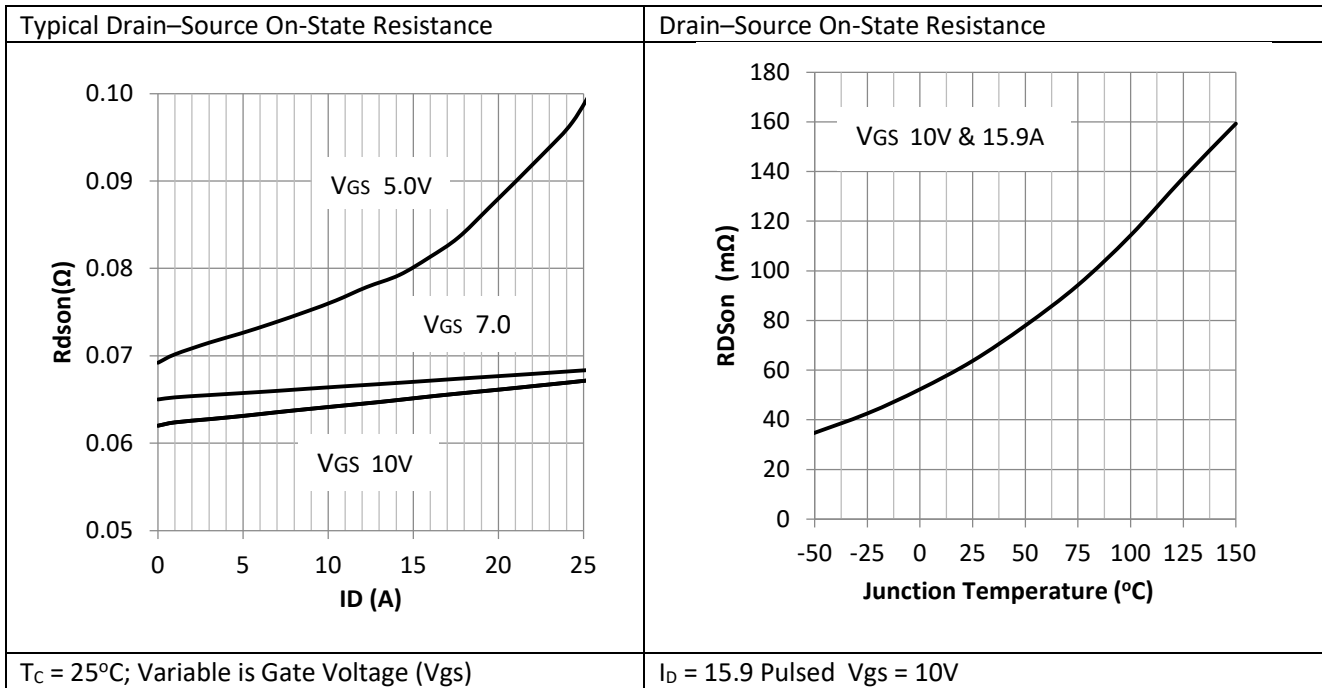


Table 11 Safe Operating Area

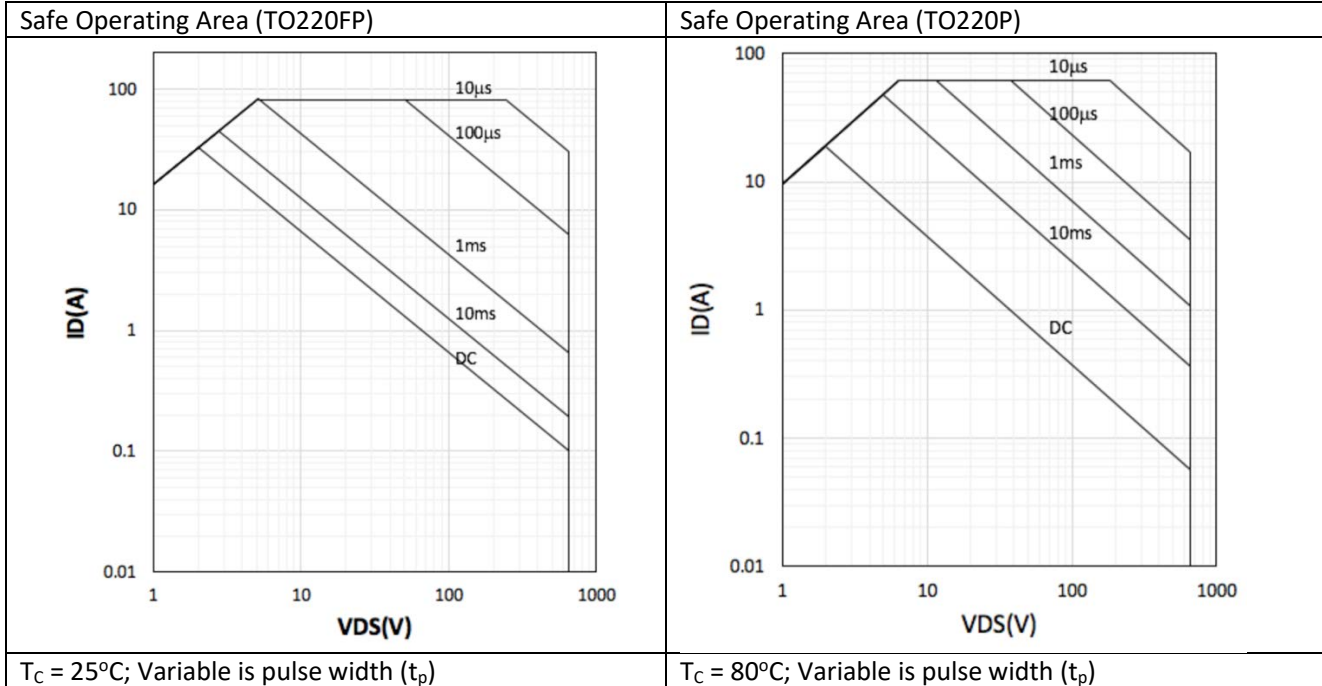
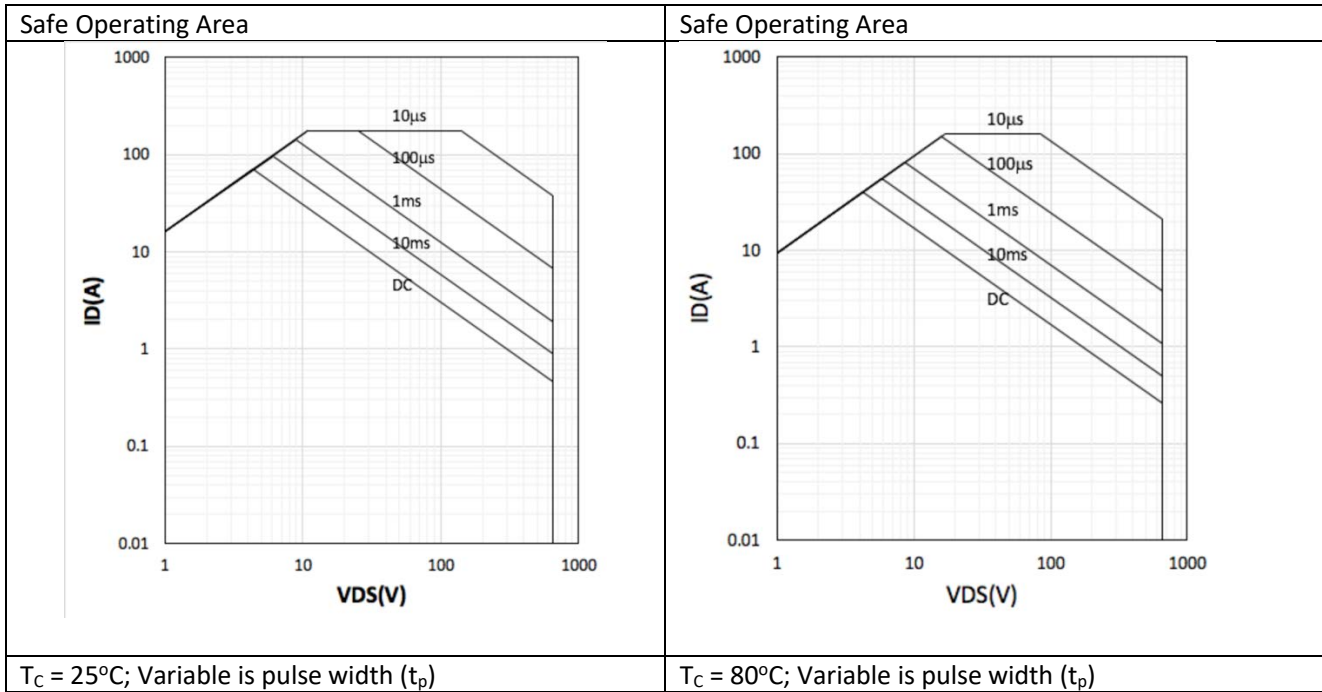


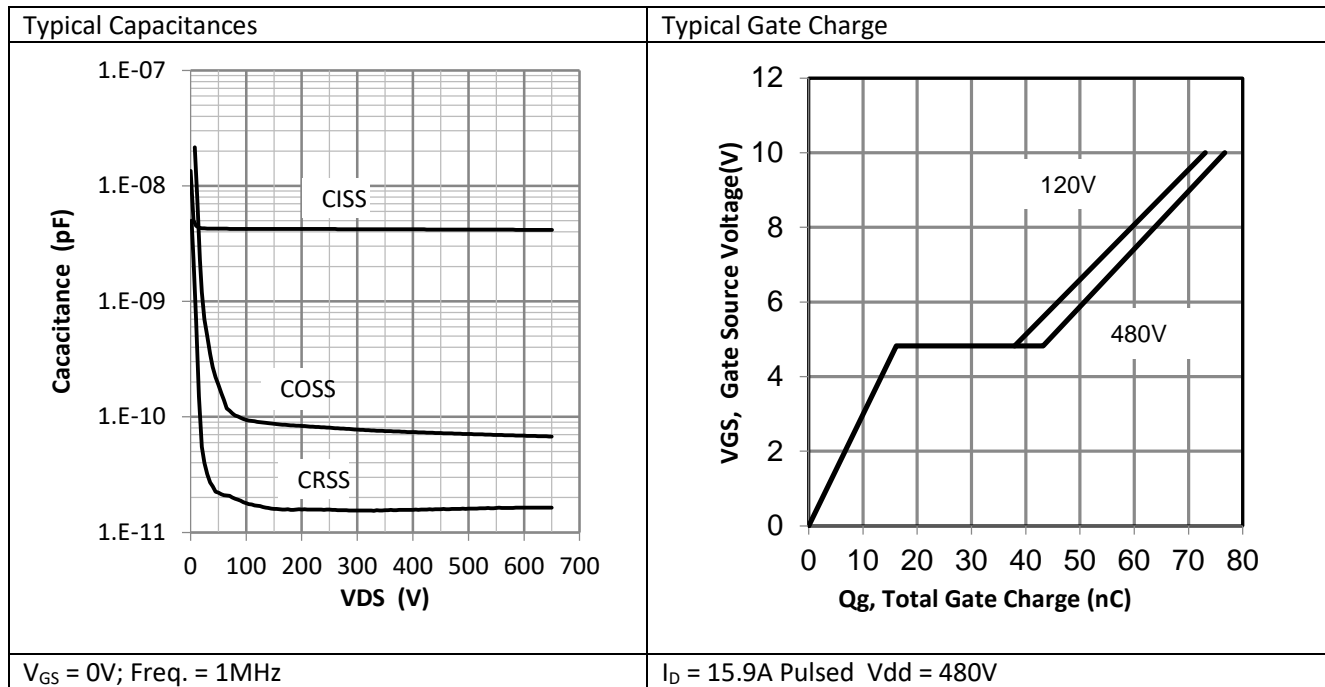
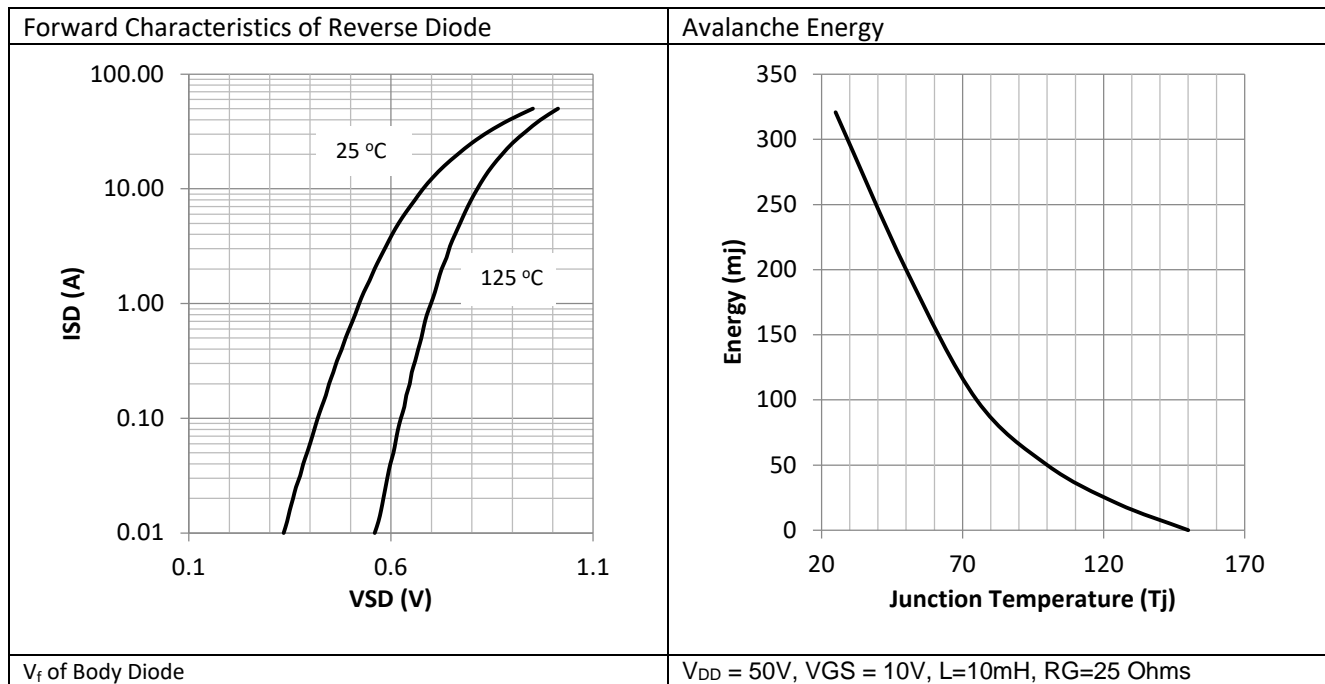
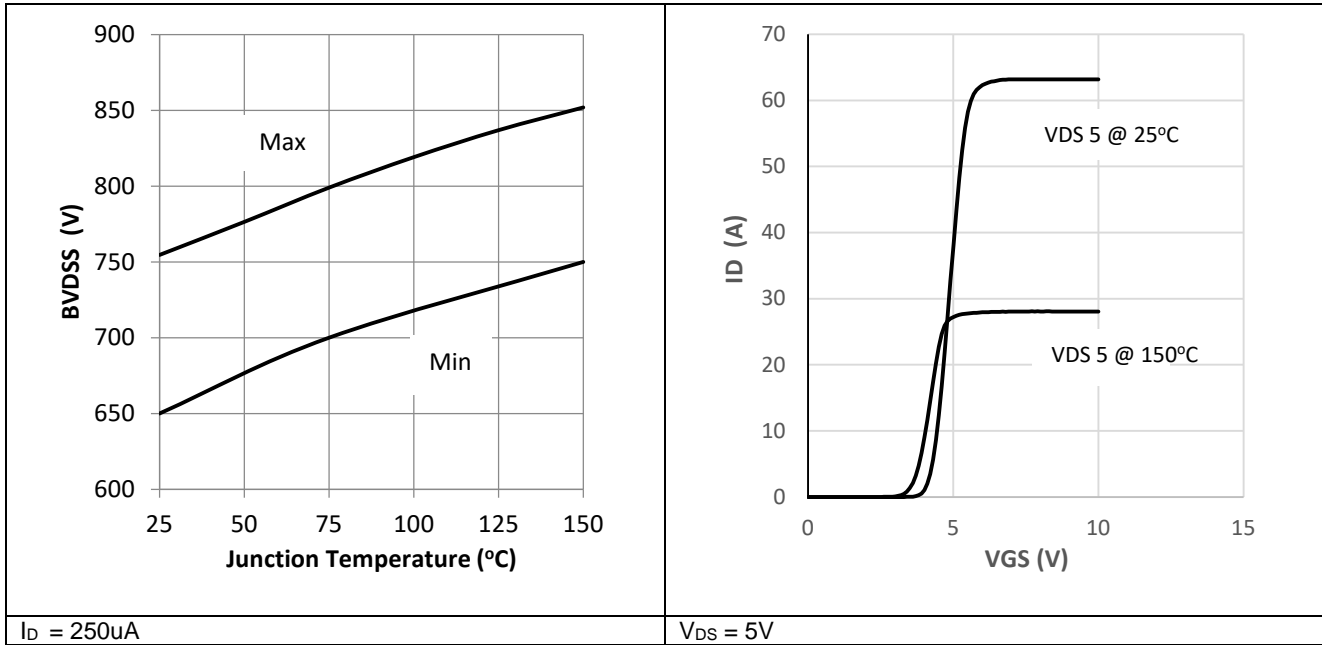
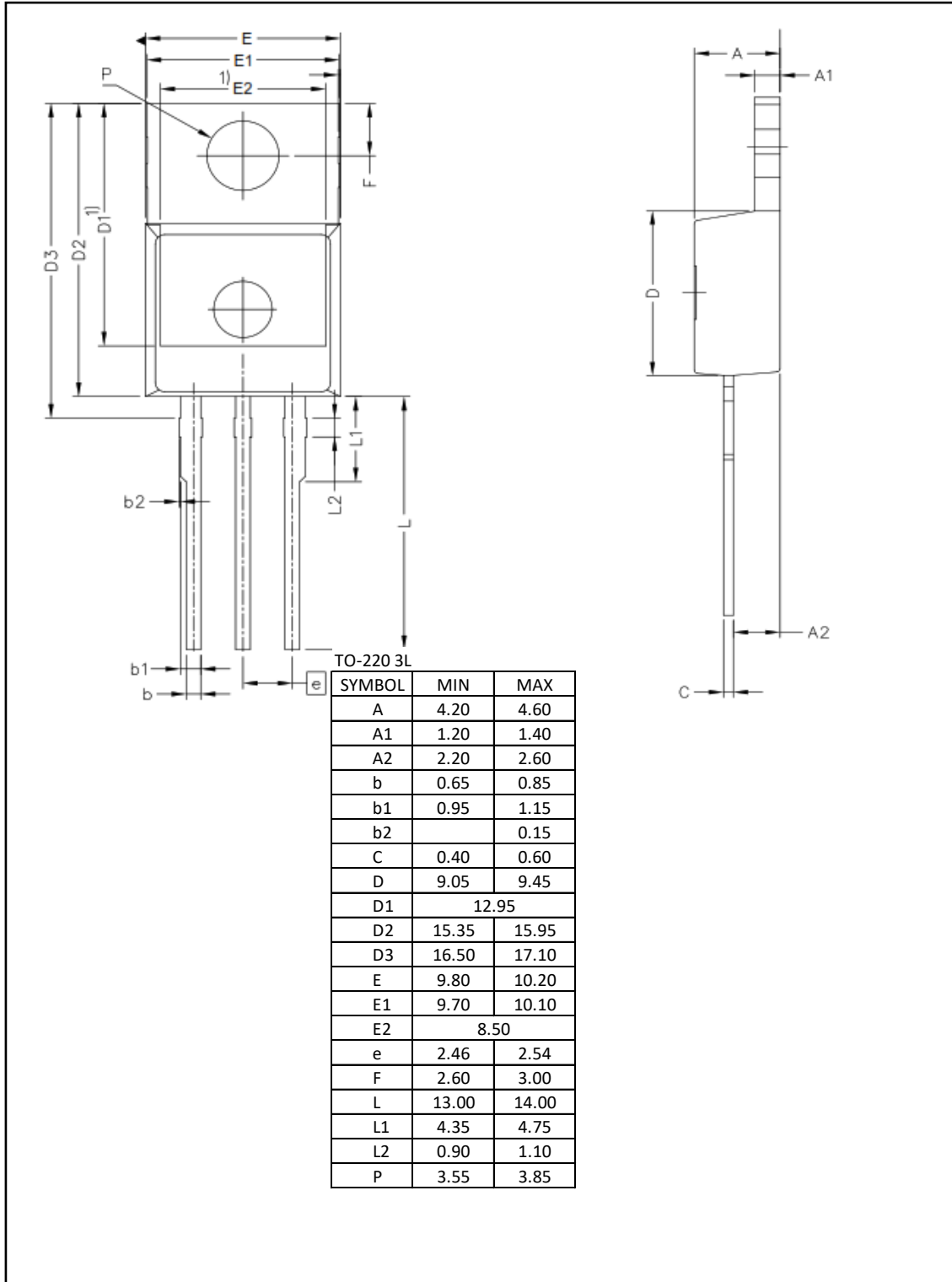
Table 12 Typical Capacitances and Gate Charge

Table 13 Diode Forward Characteristics and Avalanche Energy


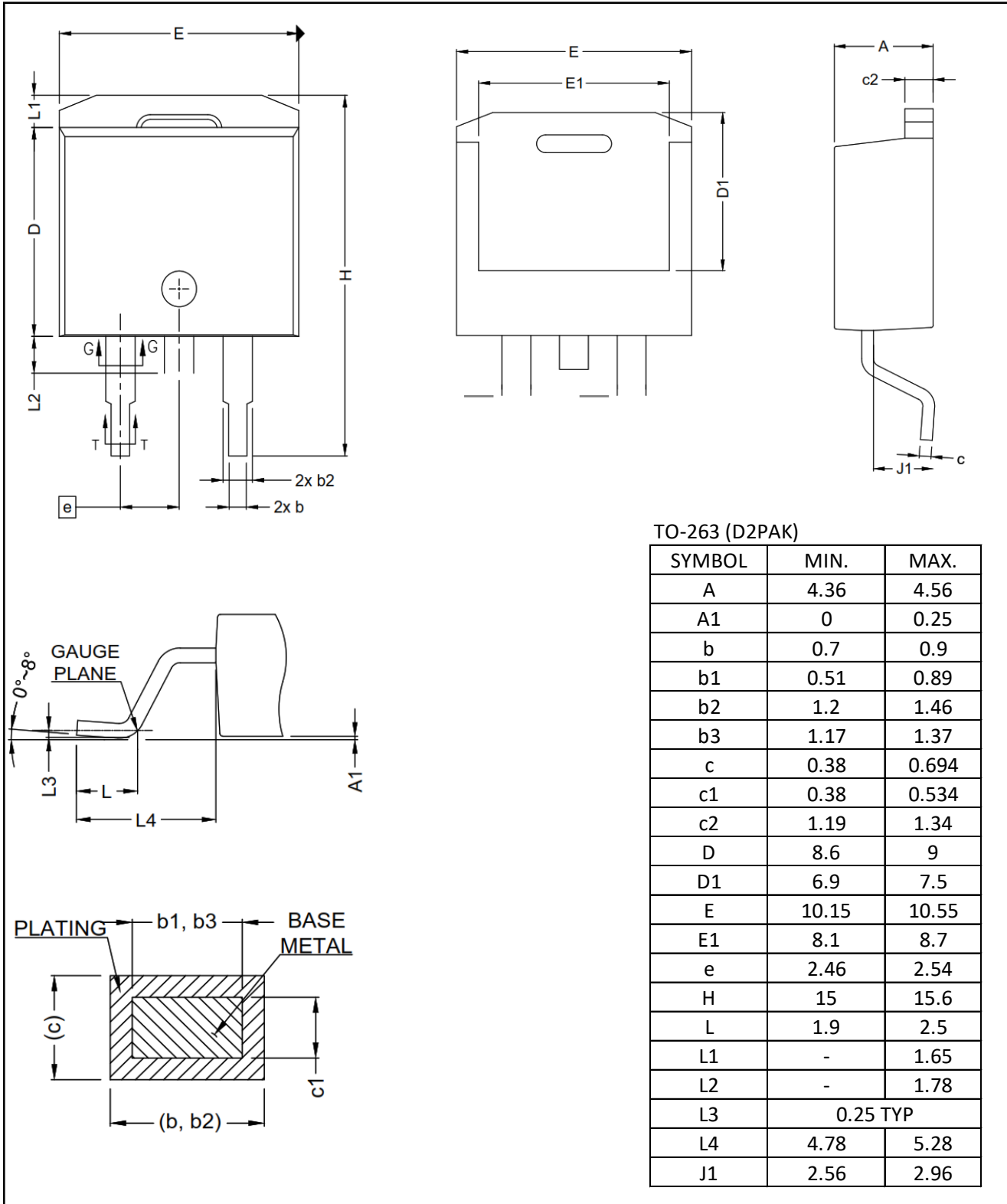
Table 14 Drain – Source Breakdown Voltage and Typical Transfer Characteristics



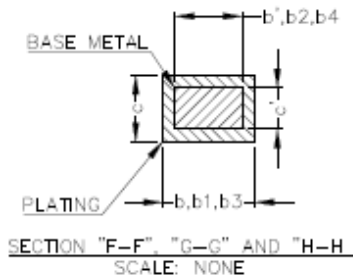
D3 Semiconductor TO-220-3L



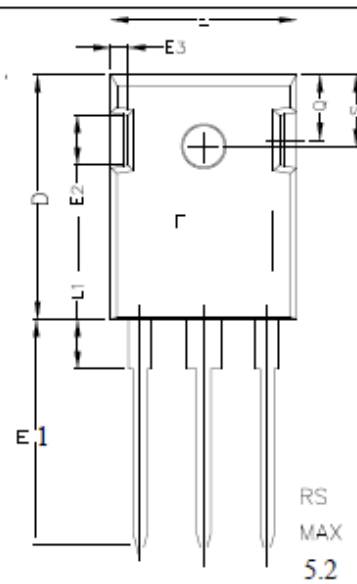
D3 Semiconductor TO-263 (D2PAK)



D3 Semiconductor TO-247-3L

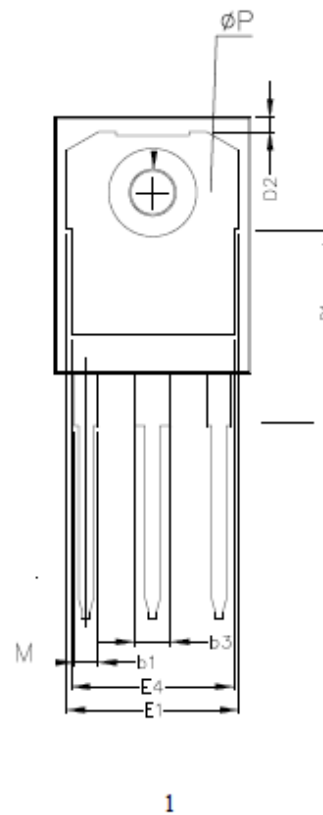
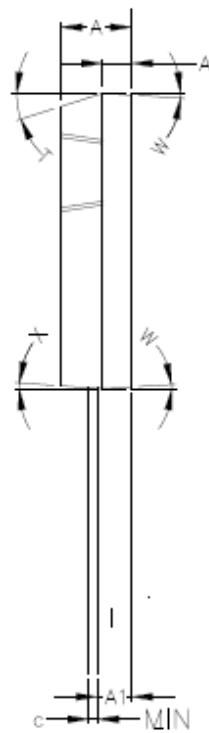


1. ALL METAL SURFACES: TIN PLATED, EXCEPT AREA OF CUT
2. DIMENSIONING & TOLERANCING CONFORM TO ASME Y14.5M-1994.
3. ALL DIMENSIONS ARE IN MILLIMETERS. ANGLES ARE IN DEGREES.
4. THIS DRAWING WILL MEET ALL DIMENSIONS REQUIREMENT OF JEDEC OUTLINES TO-247 AD.

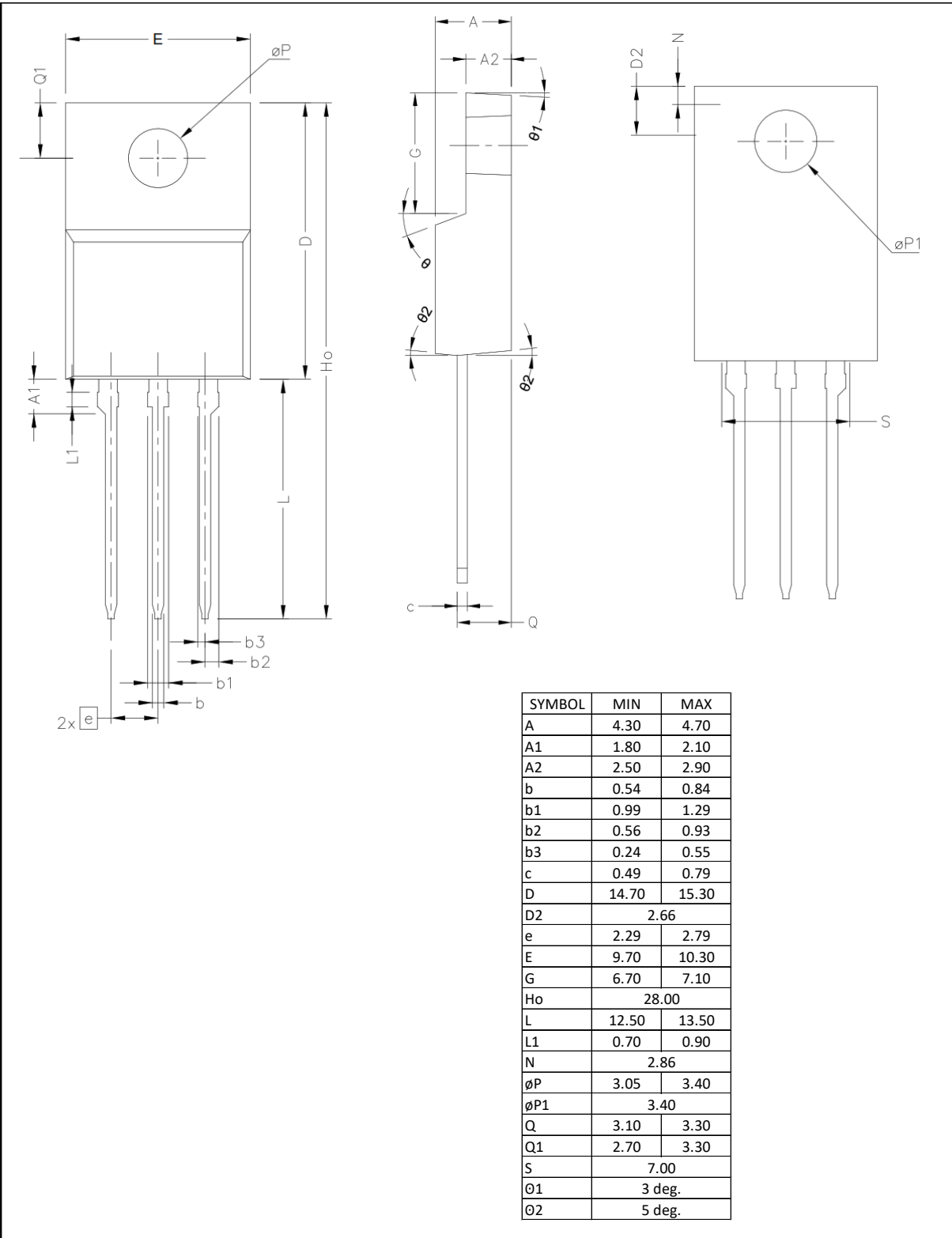


- 1 - GATE
- 2 - DRAIN (COLLECTOR)
- 3 - SOURCE (EMITTER)
- 4 - DRAIN (COLLECTOR)

SYM	MILLIMETERS	
	MIN	MAX
A	4.83	5.21
A1	2.29	2.54
A2	1.91	2.16
b'	1.07	1.28
b	1.07	1.33
b1	1.91	2.41
b2	1.91	2.16
b3	2.87	3.38
b4	2.87	3.13
c'	0.55	0.65
c	0.55	0.68
D	20.80	21.10
D1	16.25	17.65
D2	0.95	1.25
E	15.75	16.13
E1	13.10	14.15
E2	3.68	5.10
E3	1.00	1.90
E4	12.38	13.43
e	5.44 BSC	
N	3	
L	19.81	20.32
L1	4.10	4.40
øP	3.51	3.65
Q	5.49	6.00
S	6.04	6.30
T	17.5° ref	
W	3.5° ref	
X	4° ref	



D3 Semiconductor TO-220 FullPak



Revision History

Revision	Release Date	Comments
1.0	1-June-2016	Preliminary Datasheet Draft
1.1	1-Nov-2017	Datasheet Characterization Update
1.2	23-Nov-2018	Correct TO263 to E (Tape & Reel)
2.0	18-APR-2019	Update Characterization

Resources

www.d3semi.com

Patents, Copyrights and Trademarks

U.S. and Foreign Patents Pending.

The following are trademarks and service marks owned by D3 Semiconductor:

D3 Semiconductor[®], “Flying D” [®], +FET[™], Defining Precision Power[™].

All trademarks are property of their respective owners. © D3 Semiconductor 2016. All rights reserved

Legal Disclaimer

The information in this document is provided solely regarding D3 Semiconductor (“D3”) products. The information is not a guarantee of performance or characteristics. D3 Semiconductor reserves the right to modify, change, amend, improve or make corrections to this document, and its products, at any time and its sole discretion without prior written consent or notice. No license to any intellectual property rights is granted or implied under this document. D3 Semiconductor disclaims warranties and liabilities of any kind including non-infringement of intellectual property rights of any third party. D3 Semiconductor products may be used in applications such as automotive, military, aerospace, medical or other applications where failure or malfunction may result in personal injury, death or severe property or environmental damage only with express written approval from D3 Semiconductor. Sale of D3 Semiconductor products are subject to D3 Semiconductor’s standard terms and conditions. Products not purchased through D3 Semiconductor’s authorized distributors, agents or sales representatives are void of warranty.