

## 650V, 70mΩ, 43.6 Amp Super Junction Power

### Ordering Information

Part Number	Package Option
D3S070N65B-U	TO-220
D3S070N65D-U	TO-247
D3S070N65E-U	TO-263
<b>D3S070N65F-U</b>	<b>TO-220 Fullpak</b>

### Description

+FET™ is an advanced Super Junction Power MOSFET offering excellent efficiency through low R<sub>ds-ON</sub> and low gate charge. +FET™ is a rugged device with precision charge balance implementation designed for demanding uses such as enterprise power computing power supplies, motor control, lighting and other challenging power conversion applications.

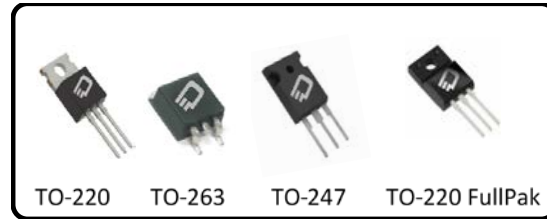
#### Features

- LOW R<sub>DS(ON)</sub>
- FAST SWITCHING
- HIGH E<sub>AS</sub>
- REL TEST SPEC: JESD-22
- HTRB >3000 HRS

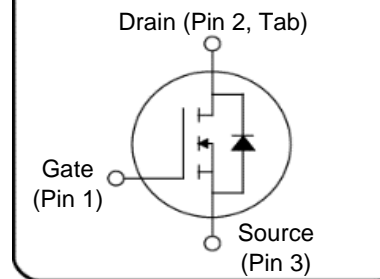
**Table 1** Key Parameters

Parameter	Value	Unit
V <sub>DSS</sub> @ T <sub>jmax</sub>	710	V
R <sub>DS(on)</sub> max	< 70	mΩ
Q <sub>g</sub> typ	77	nC
I <sub>D</sub> @ 25 °C	43.6	A

### Package Options



### Device Schematic



#### Benefits

- LOW CONDUCTION LOSSES
- HIGH EFFICIENCY
- EXCELLENT AVALANCHE PERFORMANCE

#### Applications

- POWER FACTOR CORRECTION
- SERVER POWER SUPPLIES
- TELECOM POWER SUPPLIES
- INVERTERS
- MOTOR CONTROL

## Contents

---

Contents.....	2
Maximum Ratings .....	3
Thermal Characteristics .....	4
Electrical Characteristics .....	5
Electrical Characteristics Graphs.....	7
Revision History.....	16
Resources .....	16
Patents, Copyrights and Trademarks .....	16

## Maximum Ratings

Parameter	Symbol	Values				Unit	Condition
		Min	Typ	Max			
				220 & 263	220FP		
Continuous drain current	I <sub>D</sub>			43.6	20.3	A	T <sub>C</sub> = 25°C
				27.6	12.8	A	T <sub>C</sub> = 100°C
Pulsed drain current	I <sub>D, pulse</sub>			175	81	A	T <sub>C</sub> = 25°C
Avalanche energy, single pulse	E <sub>AS</sub>			650	650	mJ	I <sub>D</sub> = 7.2A; V <sub>DD</sub> = 50V, V <sub>GS</sub> = 10V, L=10mH, R <sub>G</sub> =25 Ohms
Avalanche energy, repetitive	E <sub>AR</sub>			1	1	mJ	I <sub>D</sub> = 7.2; V <sub>DD</sub> = 50V
Avalanche current, repetitive	I <sub>AS</sub>			8.7	8.7	A	
MOSFET dv/dt ruggedness	dv/dt			50	50	V/ns	V <sub>DS</sub> = 0...480V
Gate source voltage (static)	V <sub>GS</sub>	-30		30	30	V	Static
Gate source voltage (dynamic)	V <sub>GS</sub>	-30		30	30	V	AC (F>1Hz)
Power dissipation	P <sub>tot</sub>			305	60	W	T <sub>C</sub> = 25°C
Storage temperature	T <sub>stg</sub>	-55		150	150	°C	
Operating junction temperature	T <sub>j</sub>	-55		150	150	°C	
Mounting torque				60		N-cm	M3 and M3.5 screws
					50	N-cm	M3 screw
Isolation Voltage*	V <sub>ISO</sub>	3.5				kV	TO-220 FullPak Only
Continuous diode forward current	I <sub>SD</sub>			43.6	20.3	A	T <sub>C</sub> = 25°C
Diode pulse current	I <sub>S, pulse</sub>			175	81	A	T <sub>C</sub> = 25°C
Reverse diode dv/dt	dv/dt			15	15	V/ns	V <sub>DS</sub> =0...480V, I <sub>SD</sub> <=I <sub>S</sub> , T <sub>j</sub> = 25°C
Maximum diode commutation speed	di <sub>i</sub> /dt			500	500	A/μs	V <sub>DS</sub> =0...480V, I <sub>SD</sub> <=I <sub>S</sub> , T <sub>j</sub> = 25°C

## Thermal Characteristics

**Table 3** Thermal Characteristics

Symbol	Parameter	Packages				Unit
		TO-220	TO-263	TO-247	TO-220FP	
$R_{thC}$	Thermal resistance, junction-case	0.41	0.41	0.41	1.89	°C/W
$R_{thA}$	Thermal resistance, junction-ambient	42	42	42	44	°C/W
$R_{thT}$	Thermal resistance, junction-ambient for SMD version		30			°C/W
$T_s$	Soldering temperature, wavesoldering only allowed at leads	260	260	260	260	°C

## Electrical Characteristics

@ T<sub>j</sub> = 25°C, unless otherwise specified

**Table 4**

Parameter	Symbol	Values			Unit	Condition
		Min	Typ	Max		
Drain-source breakdown voltage	V <sub>DSS</sub>	650			V	I <sub>D</sub> = 1mA, V <sub>GS</sub> = 0V
Gate threshold voltage	V <sub>(GS)th</sub>	2.3	3	3.7	V	
Zero gate voltage drain current	I <sub>DSS</sub>			1	μA	V <sub>DS</sub> = 650V, T <sub>C</sub> = 25°C
				50		V <sub>DS</sub> = 650V, T <sub>C</sub> = 125°C
Gate-source leakage current	I <sub>GSS</sub>			100	nA	
Drain-source on-state resistance	R <sub>DS(on)</sub>		0.062	0.070	Ω	V <sub>GS</sub> = 10V, I <sub>D</sub> = 15.9A, T <sub>C</sub> = 25°C
	R <sub>DS(on)</sub>		0.160			V <sub>GS</sub> = 10V, I <sub>D</sub> = 15.9A, T <sub>C</sub> = 150°C
Gate resistance	R <sub>G</sub>		1		Ω	

**Table 5**

Parameter	Symbol	Values			Unit	Condition
		Min	Typ	Max		
Input capacitance	C <sub>iss</sub>		4240		pF	V <sub>DS</sub> = 100V, f = 1MHz, V <sub>GS</sub> = 0V
Output capacitance	C <sub>oss</sub>		97.5		pF	
Reverse transfer capacitance	C <sub>rss</sub>		16.5		pF	
Turn-on delay time	t <sub>d(on)</sub>		17		ns	V <sub>DD</sub> = 400V, I <sub>D</sub> = 15.9A R <sub>G</sub> = 1Ω, V <sub>GS</sub> = 10V
Rise time	t <sub>r</sub>		24		ns	
Turn-off delay time	t <sub>d(off)</sub>		90		ns	
Fall time	t <sub>f</sub>		23		ns	

**Table 6** Gate Charge Characteristics

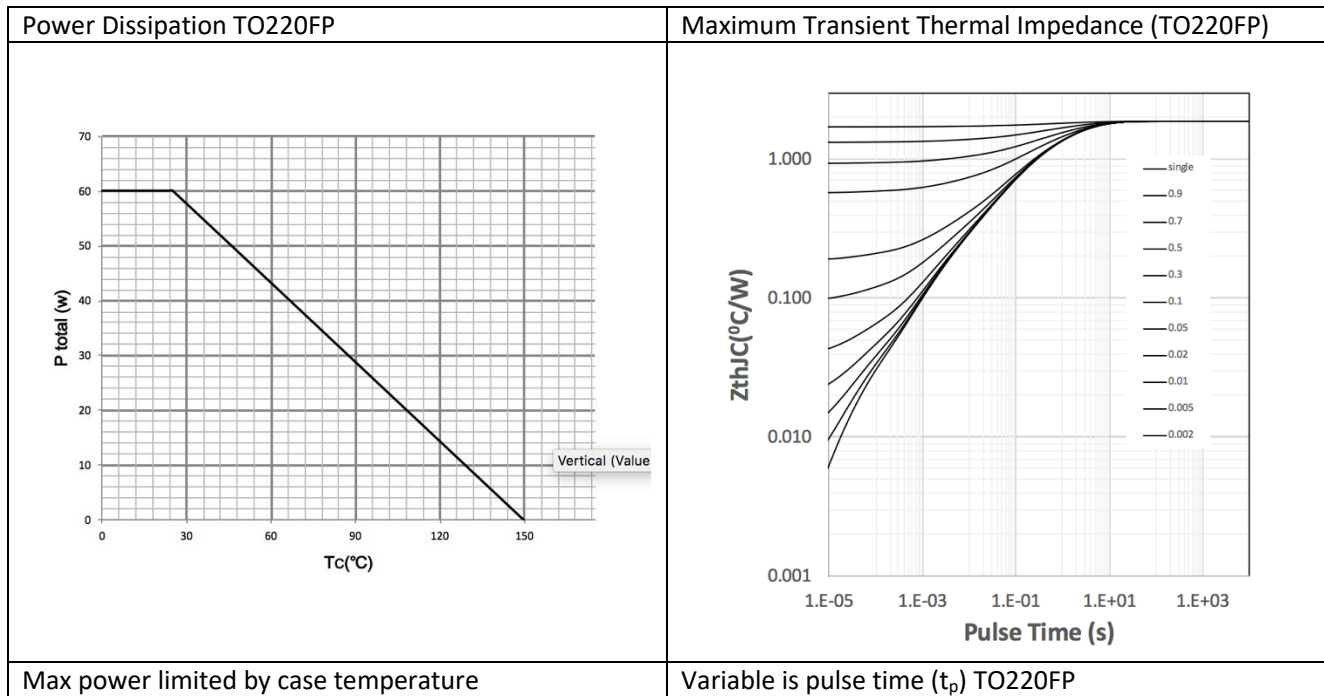
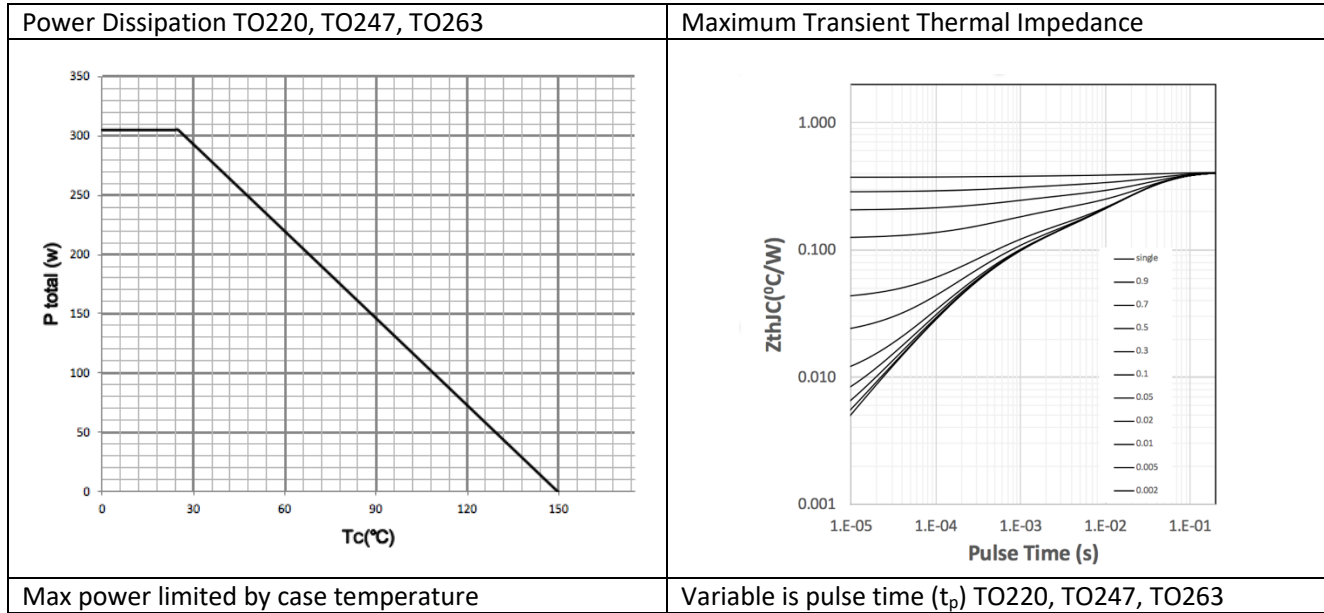
Parameter	Symbol	Values			Unit	Condition
		Min	Typ	Max		
Gate to source charge	$Q_{gs}$		16		nC	$V_{DD} = 480V, I_D = 15.5A,$ $V_{GS} = 10V$
Gate to drain charge	$Q_{gd}$		27		nC	
Gate charge total	$Q_g$		77		nC	
Gate plateau voltage	$V_{plateau}$		5		V	

**Table 7** Body Diode

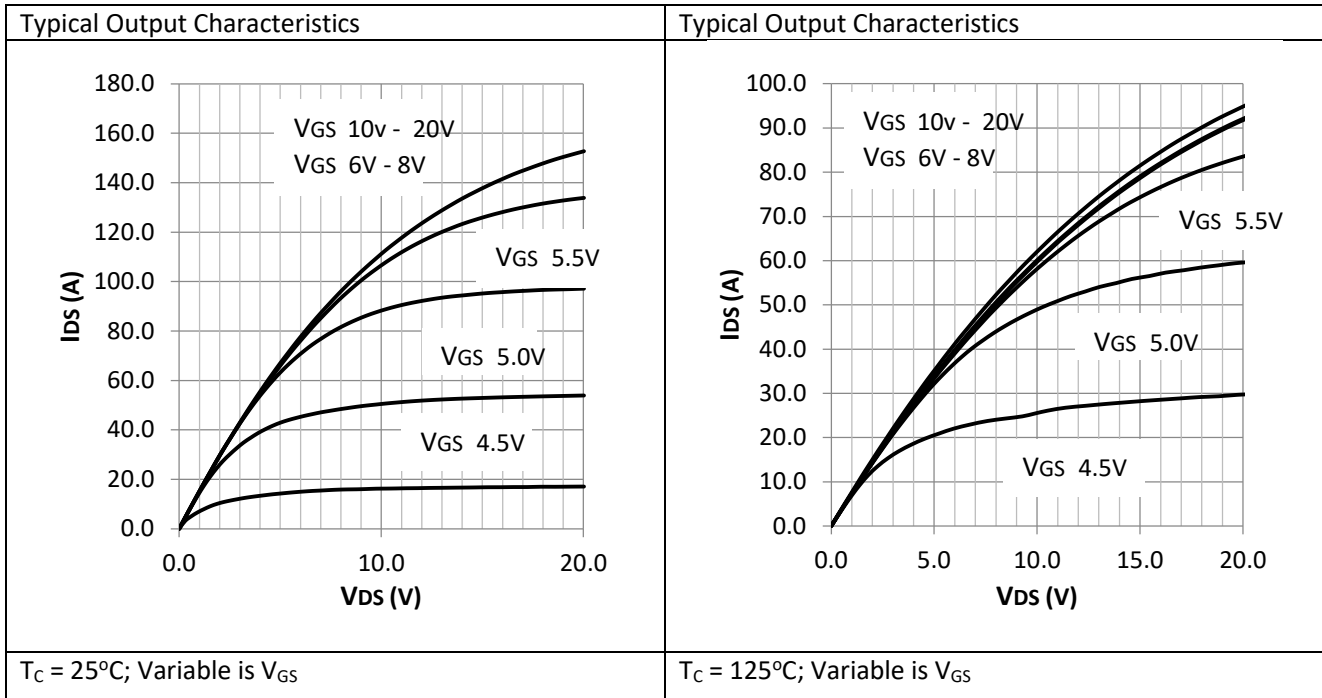
Parameter	Symbol	Values			Unit	Condition
		Min	Typ	Max		
Diode source-drain current	$I_{SD}$			43.6	A	
Diode forward voltage	$V_{fd}$		0.95	1.5	V	$I_{SD} = 31.8A, V_{GS} = 0V$
Reverse recovery time	$t_{rr}$		468		ns	$I_{SD} = 31.8A, di/dt = 100A/\mu S$ $V_{DD} = 60V, T_C = 25^\circ C$
Reverse recovery charge	$Q_{rr}$		9.5		$\mu C$	
Peak reverse recovery current	$I_{rrm}$		50.0		A	

## Electrical Characteristics Graphs

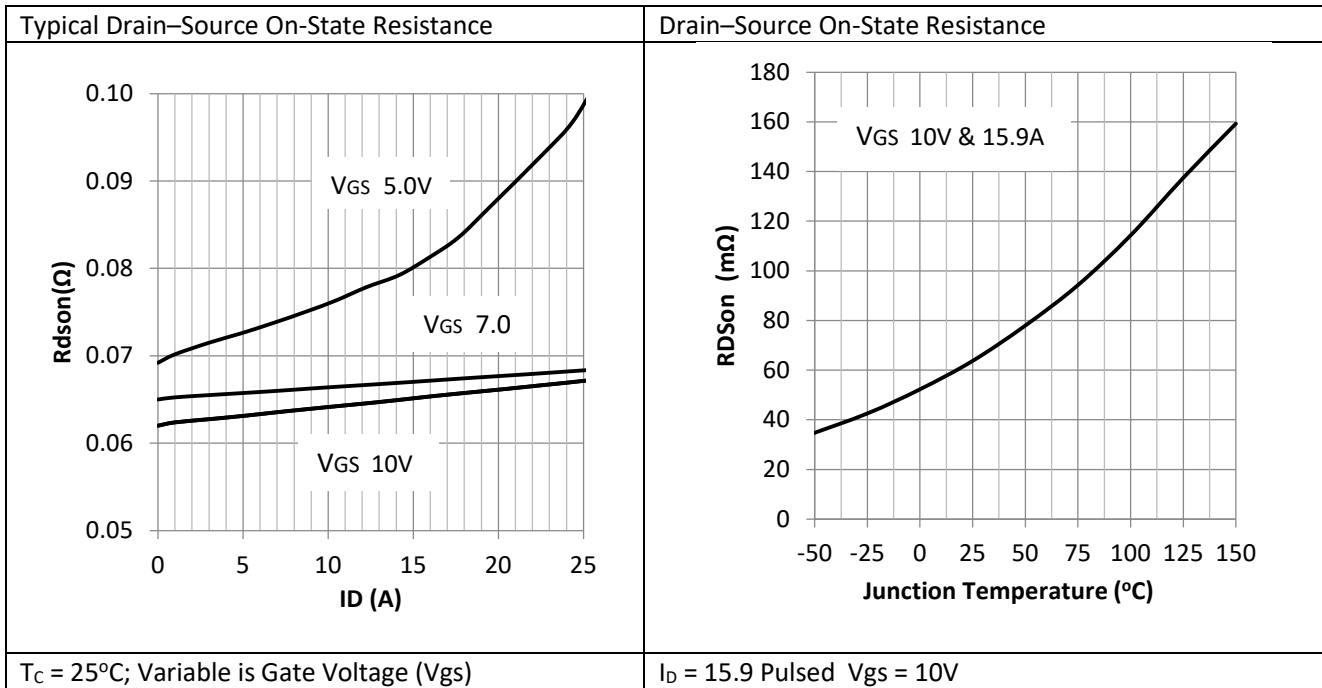
**Table 8 Thermal Performance**



**Table 9 Output Characteristics**

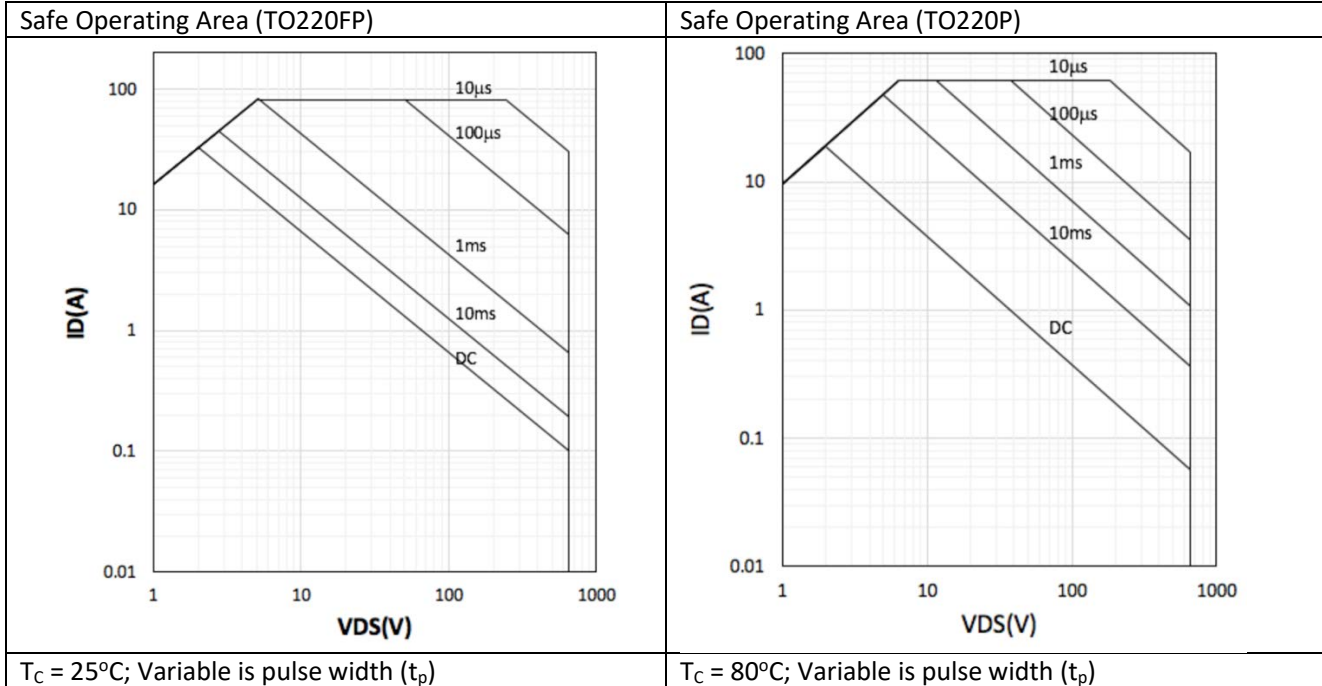
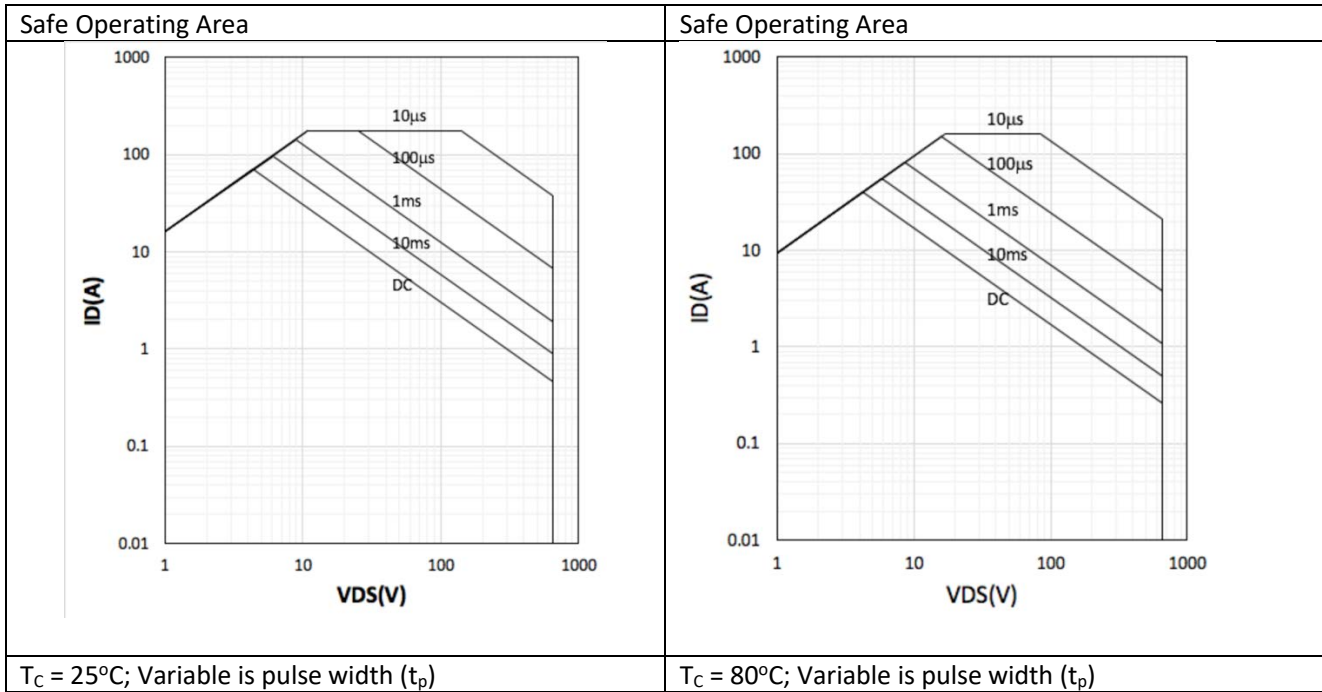


**Table 10 Drain-Source Resistance**

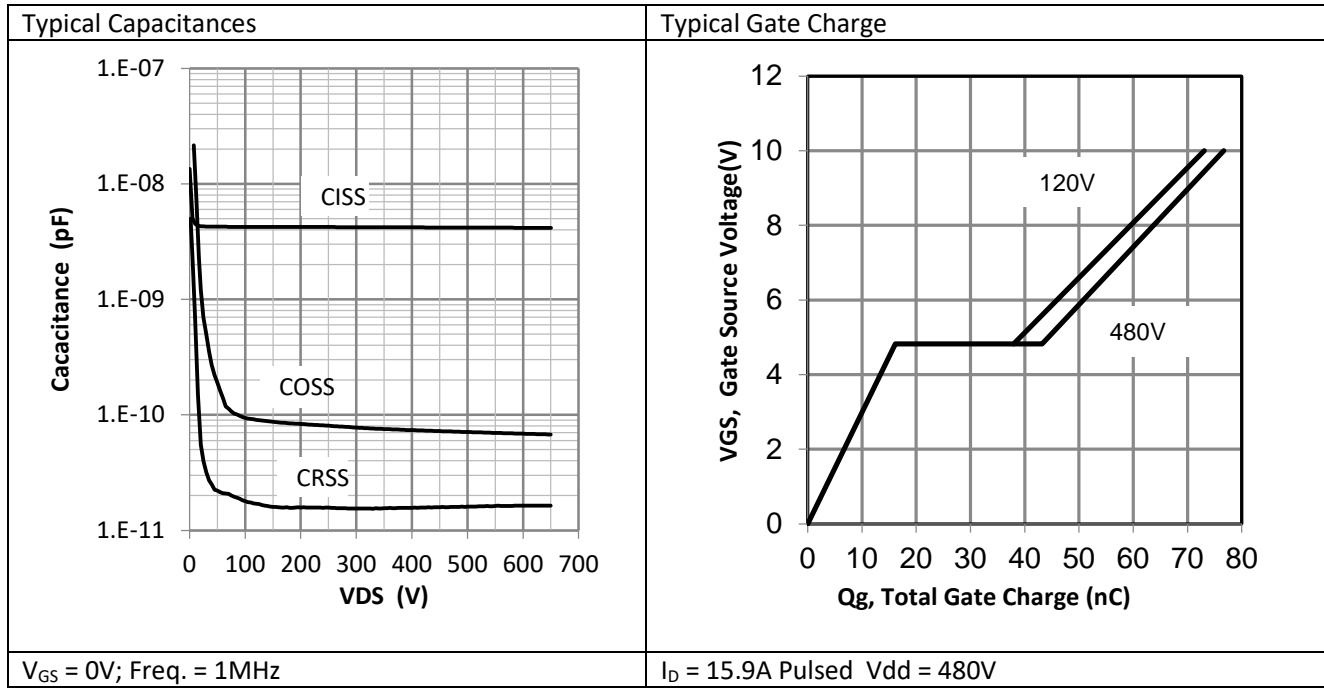




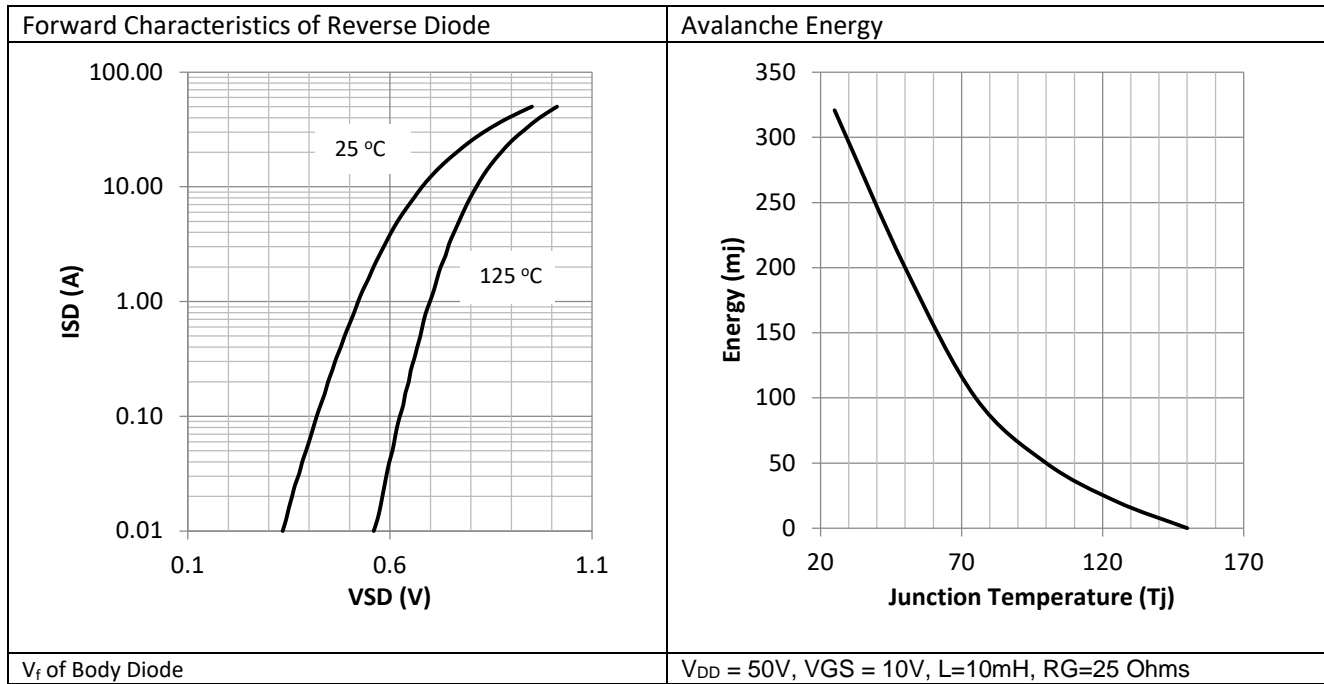
**Table 11 Safe Operating Area**



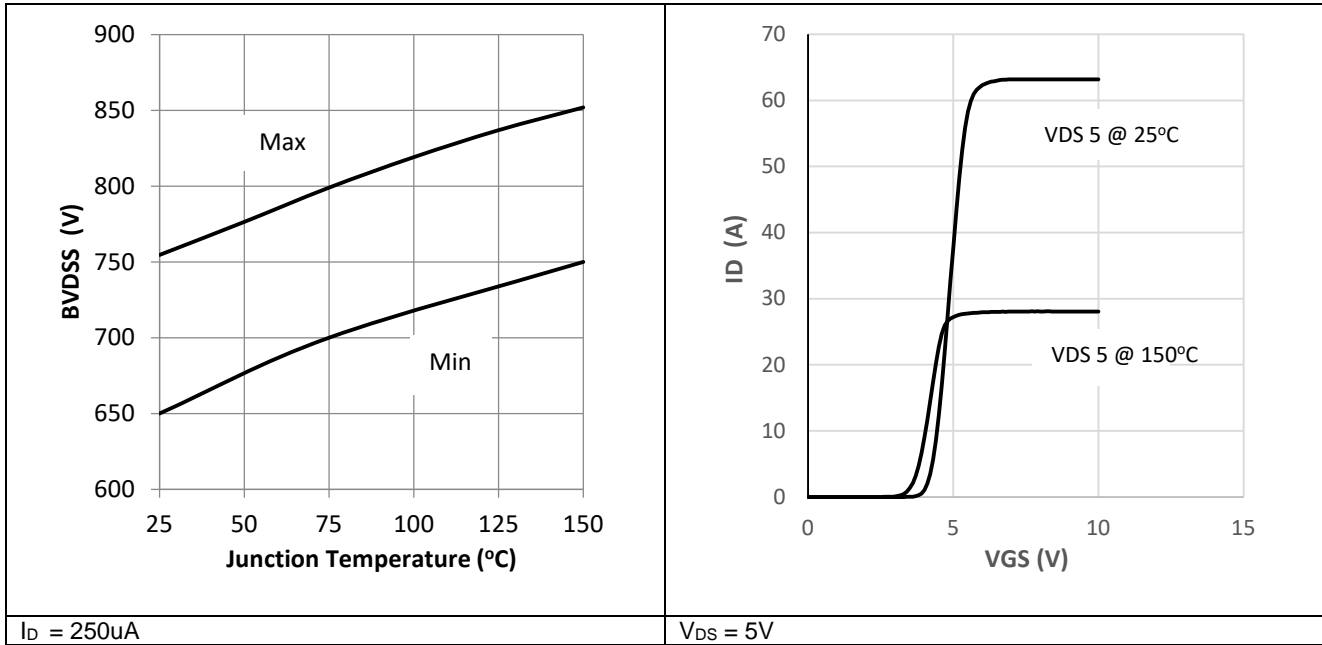
**Table 12 Typical Capacitances and Gate Charge**



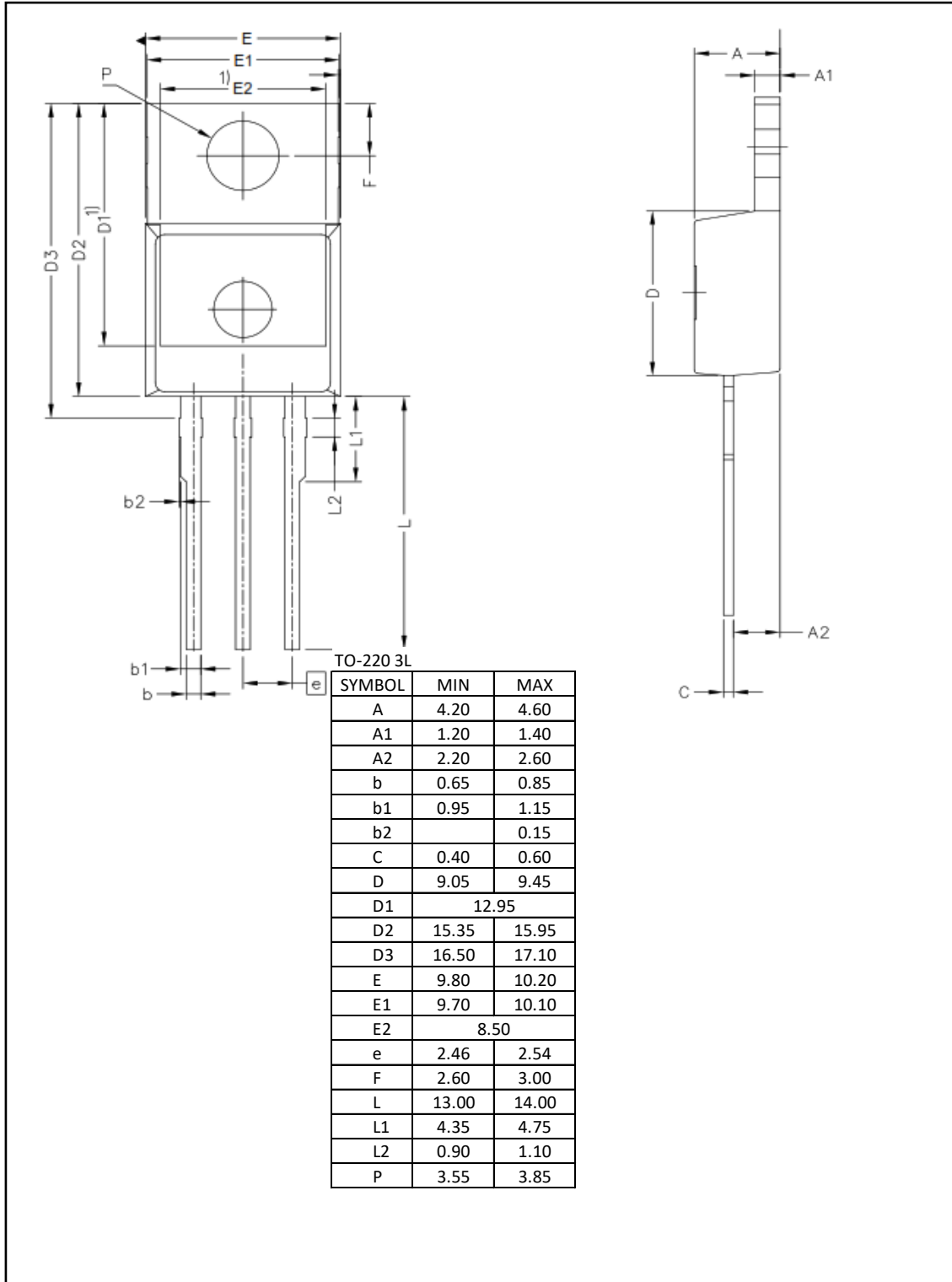
**Table 13 Diode Forward Characteristics and Avalanche Energy**



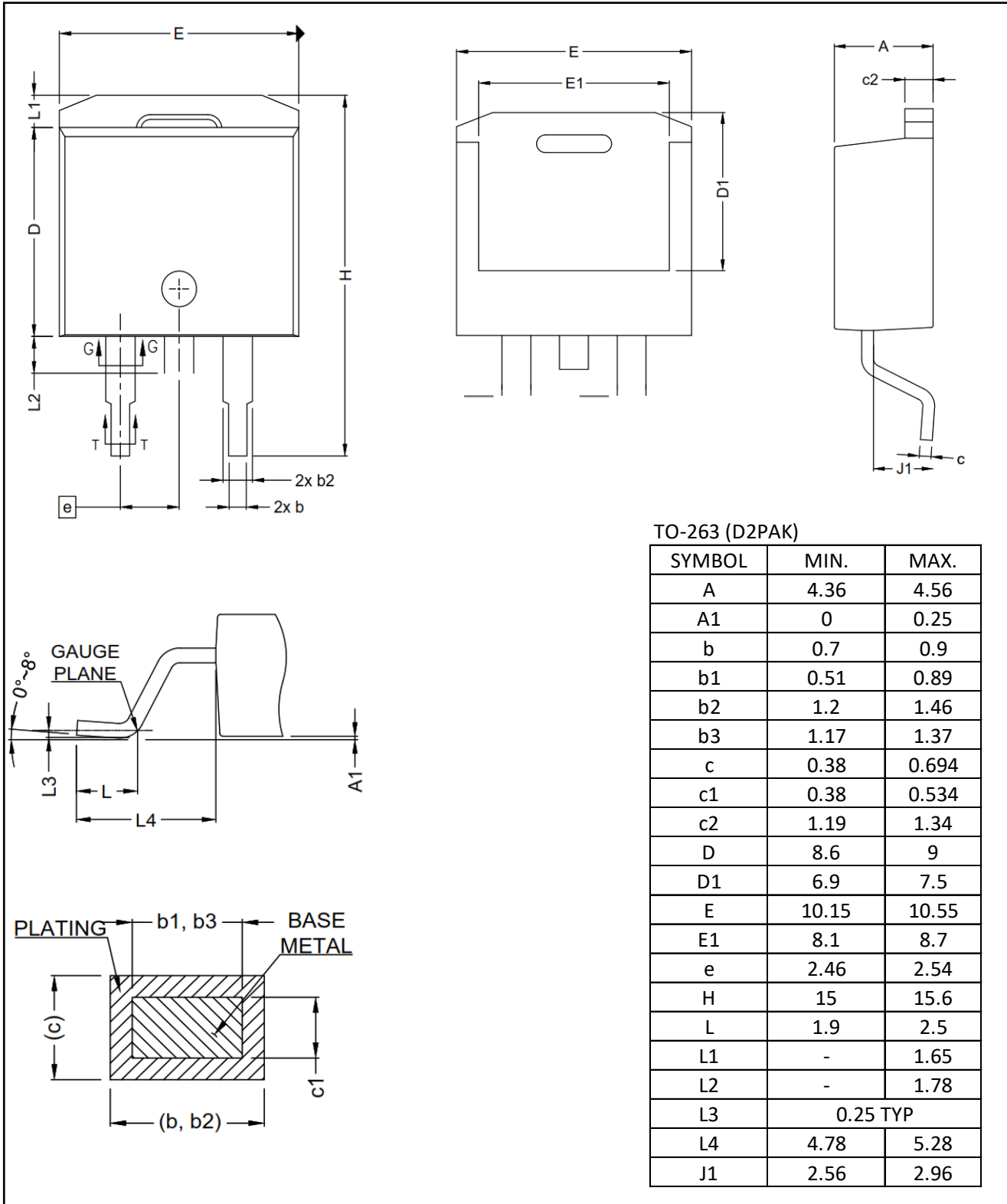
**Table 14 Drain – Source Breakdown Voltage and Typical Transfer Characteristics**



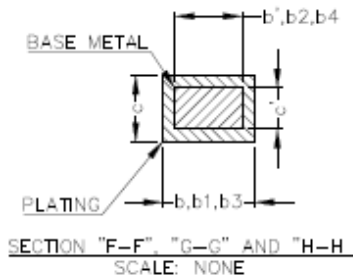
**D3 Semiconductor TO-220-3L**



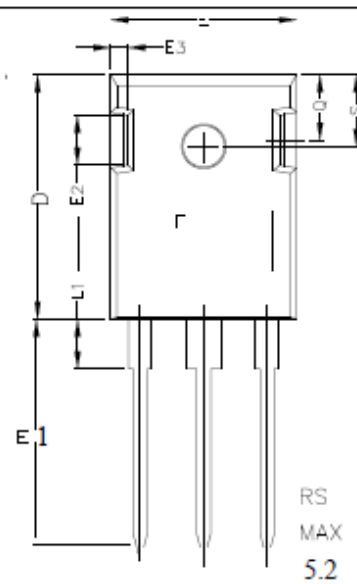
**D3 Semiconductor TO-263 (D2PAK)**



D3 Semiconductor TO-247-3L

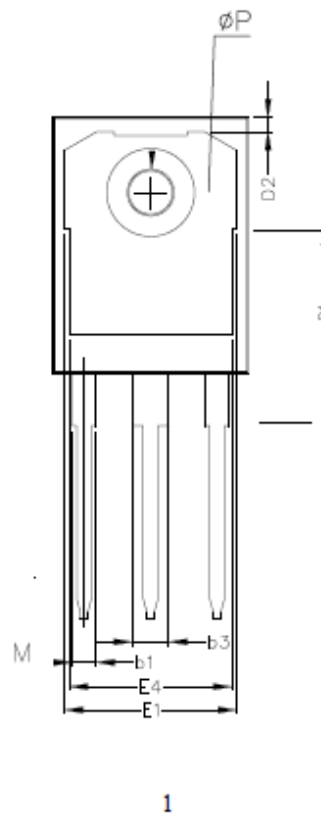
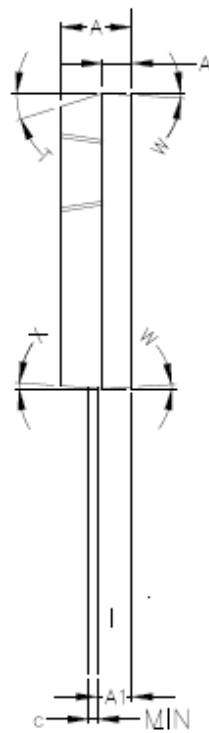


1. ALL METAL SURFACES: TIN PLATED, EXCEPT AREA OF CUT
2. DIMENSIONING & TOLERANCING CONFORM TO ASME Y14.5M-1994.
3. ALL DIMENSIONS ARE IN MILLIMETERS. ANGLES ARE IN DEGREES.
4. THIS DRAWING WILL MEET ALL DIMENSIONS REQUIREMENT OF JEDEC OUTLINES TO-247 AD.

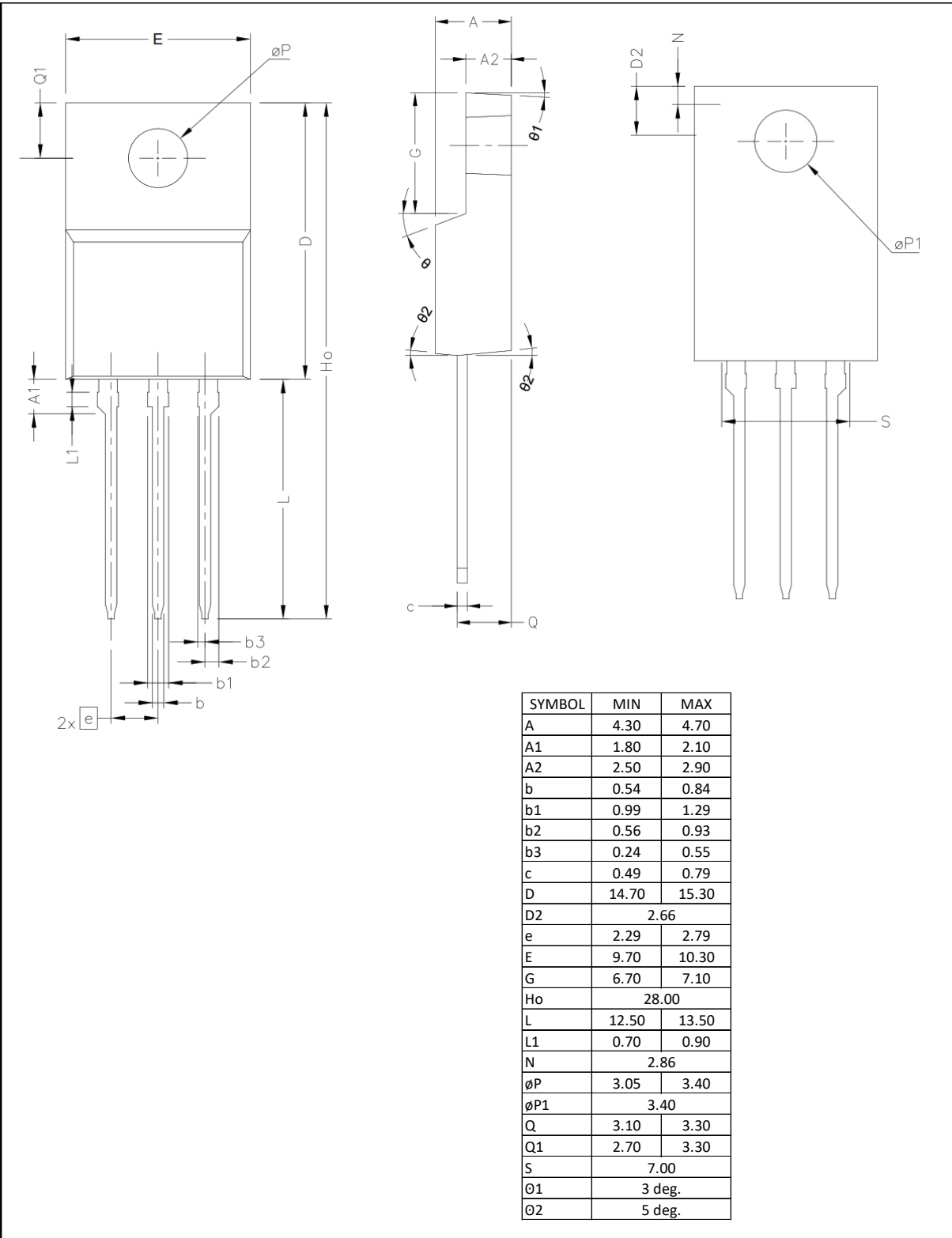


SYM	MILLIMETERS	
	MIN	MAX
A	4.83	5.21
A1	2.29	2.54
A2	1.91	2.16
b'	1.07	1.28
b	1.07	1.33
b1	1.91	2.41
b2	1.91	2.16
b3	2.87	3.38
b4	2.87	3.13
c'	0.55	0.65
c	0.55	0.68
D	20.80	21.10
D1	16.25	17.65
D2	0.95	1.25
E	15.75	16.13
E1	13.10	14.15
E2	3.68	5.10
E3	1.00	1.90
E4	12.38	13.43
e	5.44 BSC	
N	3	
L	19.81	20.32
L1	4.10	4.40
øP	3.51	3.65
Q	5.49	6.00
S	6.04	6.30
T	17.5° ref	
W	3.5° ref	
X	4° ref	

- 1 - GATE
- 2 - DRAIN (COLLECTOR)
- 3 - SOURCE (EMITTER)
- 4 - DRAIN (COLLECTOR)



**D3 Semiconductor TO-220 FullPak**



## Revision History

Revision	Release Date	Comments
1.0	1-June-2016	Preliminary Datasheet Draft
2.0	14-Nov-2017	Designers Datasheet
2.5	20-Nov-2017	Added TO247 Package
3.0	04-Apr-2019	Added TO220FP Package

## Resources

[www.d3semi.com](http://www.d3semi.com)

## Patents, Copyrights and Trademarks

U.S. and Foreign Patents Pending.

The following are trademarks and service marks owned by D3 Semiconductor:

D3 Semiconductor<sup>®</sup>, “Flying D” <sup>®</sup>, +FET<sup>™</sup>, Defining Precision Power<sup>™</sup>.

All trademarks are property of their respective owners. © D3 Semiconductor 2016. All rights reserved

## Legal Disclaimer

The information in this document is provided solely regarding D3 Semiconductor (“D3”) products. The information is not a guarantee of performance or characteristics. D3 Semiconductor reserves the right to modify, change, amend, improve or make corrections to this document, and its products, at any time and its sole discretion without prior written consent or notice. No license to any intellectual property rights is granted or implied under this document. D3 Semiconductor disclaims warranties and liabilities of any kind including non-infringement of intellectual property rights of any third party. D3 Semiconductor products may be used in applications such as automotive, military, aerospace, medical or other applications where failure or malfunction may result in personal injury, death or severe property or environmental damage only with express written approval from D3 Semiconductor. Sale of D3 Semiconductor products are subject to D3 Semiconductor’s



standard terms and conditions. Products not purchased through D3 Semiconductor's authorized distributors, agents or sales representatives are void of warranty.